

# Lifting Clamps

## Product Warnings Manual



**Applications, Operating and  
Maintenance Instructions**

# Table of Contents

Table of Contents.....	2
Warning and General Information .....	2 - 3
Applications.....	4
Definitions.....	5 - 6
Safe Use of Campbell® Lifting Clamps.....	7 - 9
Lifting Clamp Models	
GX .....	10 - 13
GX Structural.....	10
GX Sharp Leg.....	10
GXL.....	14 - 18
SAC.....	19 - 22
E.....	23 - 26
H.....	27 - 30
GXRPC.....	31 - 34
Duplex Hand Grip.....	35
Drum Handling Equipment	
Single Drum Lifter, No. 52 .....	36 - 37
Double Drum Lifter, No. 252.....	38
Fork Truck Drum Lifter, No. 260.....	39
Maintenance and Inspection .....	40 - 43

## **WARNING:**

Prior to selection, operation and/or maintenance of Campbell® Clamps, read and understand the information provided in this manual.

The understanding and use of Definitions are important in determining the limitations and proper applications of lifting clamps.

Failure to review and utilize recommended applications, operation and maintenance instructions may result in serious injury to operator and others.

THIS PUBLICATION SUPERSEDES ALL PREVIOUSLY PUBLISHED AND/OR DISTRIBUTED INFORMATION BY MANUFACTURER AND/OR ITS DISTRIBUTORS WITH RESPECT TO APPLICABLE CAMPBELL (PREVIOUSLY MERRILL) LIFTING CLAMPS AND SUBJECT MATTER DESCRIBED OR CONTAINED HEREIN.

**To Our Valued Customers:**

Campbell® lifting clamps are known world-wide for lifting and conveying sheet steel, fabricated sections and structural members. Within their capacity, the heavier the load, the tighter they grip. Parts are drop forged and heat treated from prime quality steel for long life and great strength relative to their weight. All Campbell lifting clamps are individually inspected and proof tested to two times their working load limit. Replacement parts are widely available and easy to install.

In addition to producing high quality products, we also give you complete instructions on operating, inspecting, maintaining and safely using our clamps. The Campbell Lifting Clamps Product Warnings manual describes the applications, operating and maintenance instructions for all our lifting clamps. The Operator's Manual is supplied with the purchase of a new clamp and covers the specific model of clamp.

Campbell lifting clamps, like many other products, are often used in work environments which can be dangerous. It would be impossible for any manual to describe all of the ways that a product could be misused. Campbell warnings are intended to identify only the most common risks. As a distributor or end user, it is your explicit responsibility to identify the risk factors before putting any product into service. If you have any doubts as to the clamp best suited to your application, contact your Campbell® distributor.

If you would like to receive additional copies of this manual or any Operator's Manuals, contact your Campbell® distributor or call us at (919) 362-1670.

### **Warranty Exclusion**

Any warranty, express or implied, which exceeds the descriptions stated in this catalog or in our other materials, is not valid.

## Applications

Campbell® clamps may be used for various applications.

- Lifting, turning over and transfer of steel plates
  - Model GX (No 180° Turns for GX Sharp Leg)..... 10
  - Model GXL ..... 14
  - Model SAC ..... 19
  
- Vertical lifting and transfer of steel plates
  - Model E ..... 23
  
- Lifting, turning and mounting of wide flange beams and shape steel
  - Model GX Structural ..... 10
  - Model GXL ..... 14
  
- Horizontal lifting and positioning of steel plates
  - Model H..... 27
  
- Vertical lifting and turning of hard or polished plates
  - Model GXRPC ..... 31
  
- Lifting stacked plates from horizontal to vertical position
  - Model GX Sharp Leg ..... 10
  
- Hand or conveyer carry of plates and shape steel
  - Duplex Hand Grip ..... 35
  
- Lifting and transfer of drums
  - Single Drum Lifter, No. 52 ..... 36
  - Twin Drum Lifter, No. 252 ..... 38
  - Fork Truck Drum Lifter, No. 260 ..... 39

## DEFINITIONS

**VERTICAL LIFT:** The lifting of a vertical plate or member in which the lifting force exerted by the rigging is evenly distributed and is directly above and in line with the clamp's lifting shackle. This is illustrated in (Fig. 1).

**VERTICAL TURN/LIFT:** Turns a single plate or member from horizontal to vertical through a 90° arc, and back to vertical through the same 90° arc; or from horizontal to vertical to horizontal through 180° arc (Fig. 2).

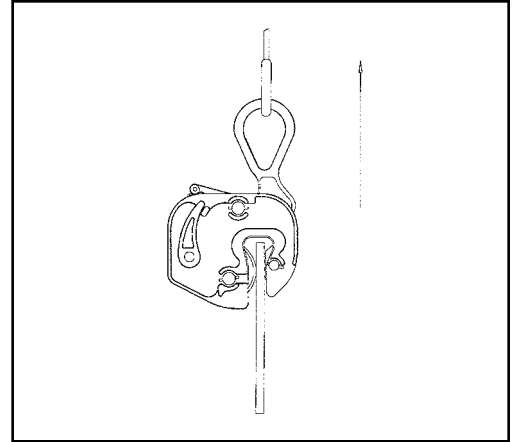

Figure 1

**HORIZONTAL LIFT:** Multiple clamps are attached to the sides of a horizontal plate. The clamps are attached to a multi-leg sling or spreader bar centered over the plate (Fig. 3).

**FINISHED OR POLISHED PLATES:** Steel plates such as stainless steel which have other than hot-rolled surfaces are generally handled with a non-marring clamp that has at least one smooth gripping surface.

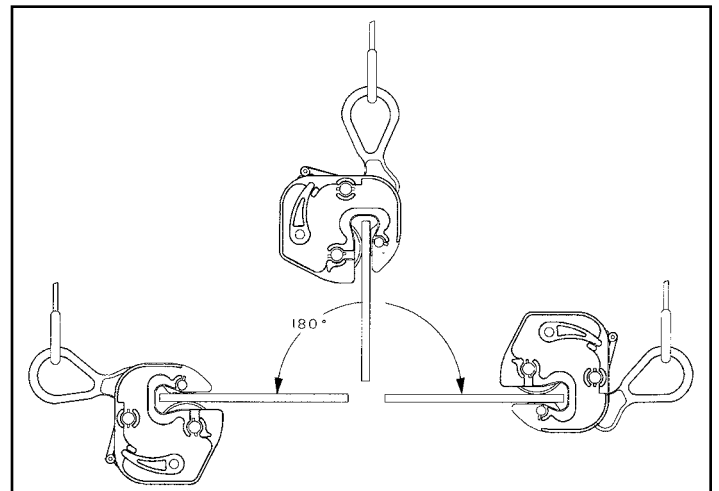

Figure 2



**WARNING!:** The capacity of all horizontal clamps is based on a sling angle of 60°. Sling angles less than 60° increase the load exerted on the clamps.

**STRUCTURAL MEMBERS AND FABRICATED SECTIONS:** Unless otherwise specified, clamps recommended for structural members or fabricated sections are limited to steel products with a hardness not greater than 400 Brinell (43 Rockwell C). For other applications contact your Campbell® distributor for lifting recommendations.

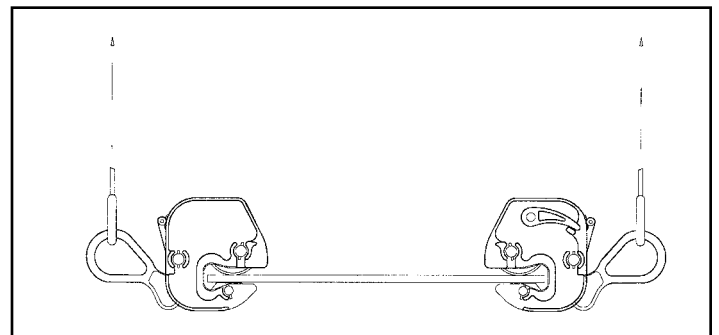

Figure 3

**RATED CAPACITY:** The rated capacity of a Campbell® clamp is based on a clamp in “new” or “as new” condition. It is the maximum load that the product may lift when used in the way described in this manual. Wear, misuse, abuse and other use factors may lower the rated capacity. These factors and shock loading must be considered when choosing a Campbell clamp for a job.

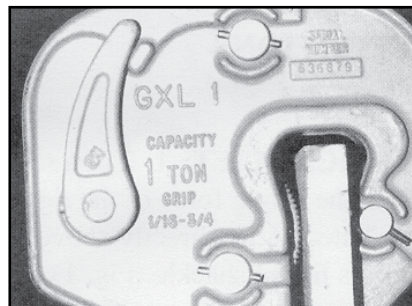

Figure 4

**WORKING LOAD LIMIT (WLL):** The maximum load that should ever be applied to a Campbell clamp. The Working Load Limit is forged into or stamped on the body of every clamp (Fig. 4).

**SHOCK LOAD:** A force that results from the rapid movement of a load. A shock load force is much greater than a force of a motionless load.

**GRIP RANGE:** The minimum and maximum plate thickness that a clamp can lift.

**JAW OPENING:** The capacity (grip range) of a clamp in terms of plate thickness.



**WARNING!:** Never lift a plate that is not within the grip range forged or stamped on the clamp.

**OPERATING TEMPERATURES:** Campbell clamps are designed for operation only in temperatures ranging from 0 to 200 degrees Fahrenheit. This range applies to both ambient and material temperatures.

**LEVER-OPEN/ LEVER-CLOSED:** This feature makes it easier to attach and remove the clamp. A lever-actuated spring holds the cam in contact (lever closed) or away from (lever open) the plate.

**CAM ENGAGING LEVER (Locking Lever):** A lever or chain activated spring that holds the cam away from or in contact with the plate. This makes clamp operation easier. The Campbell “GXL” and “E” clamps have this feature. These clamps will not lift a plate when in the “lock open” position.

**SCREW-ADJUSTED CAM:** Convex cylindrical cams attached to a special screw which, when tightened, places and keeps the cam in contact with the plate.

**SPRING-LOADED CAM:** Cam loaded by double torsional spring, which stays engaged even under “no load” conditions.



**WARNING!:** A notice pointing out danger, informing the operator and others that they should protect themselves.

## SAFE USE OF CAMPBELL LIFTING CLAMPS (DO'S AND DON'TS)

More than 90% of lifting clamp accidents are caused by incorrect handling or use. Special attention is required when the work is familiar or clamps become old. For your own safety, read the following warnings carefully, and be careful not to use clamps improperly and dangerously. All warning information must be made available to product users specifically before the first use, and at all times afterward, for reference and updates.

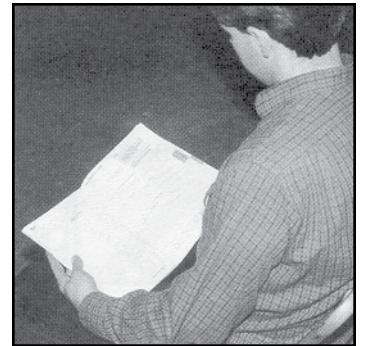

Figure 5

1. **DO** use the right clamp for the job. Before using Campbell clamps, carefully read the instructions and warnings in our product literature, and understand them thoroughly (Fig. 5). **MOST IMPORTANTLY** always stay clear of the load when lifting! The operator should never lift over people or machinery (Fig. 14). If you are not sure, contact a Campbell representative for proper use of our products.

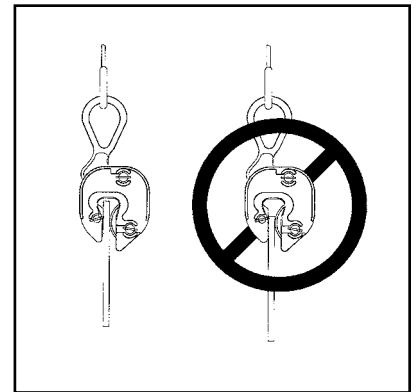

Figure 6

2. **DO NOT** lift a plate which cannot be inserted all the way into the clamp's throat opening. Insert the plate or flange to the full depth of the throat opening (Fig. 6). It is absolutely necessary for the cam and pad to have maximum contact on the plate to ensure a good, firm grip on the plate.

3. **DO NOT** use a clamp on a member whose thickness is less or more than the grip range shown on the clamp. Every Campbell clamp has its lifting capacity and grip range forged or stamped into the body (Fig. 7).

4. **DO** know the exact weight of the lifted member before the lift (Fig. 8). Never lift a weight greater than the Working Load Limit (WLL) of the clamp.



Figure 7

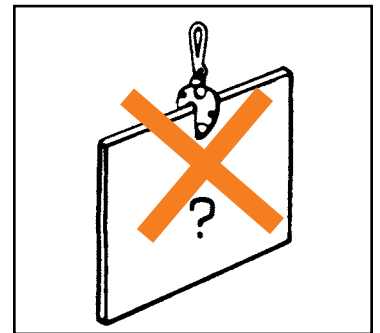

Figure 8

5. **DO** match the clamp working load capacity to the weight of the load. **DO NOT** use a big clamp to lift a small load.

6. **DO** place the pad side (short leg) of the clamp under the plate when lifting from horizontal to vertical position with clamps other than GX or GXL models (Fig. 9).
7. **DO NOT** use a clamp that needs repair. Inspect the clamp prior to each lift. Refer to the Clamp Maintenance and Inspection section of this manual for detailed instructions .
8. **DO NOT** lift a plate or member whose hardness is greater than 400 Brinell (43 Rockwell C) with any clamp other than a non-marring clamp.
9. **DO NOT** attach a clamp to an oily surface or any surface other than a clean, dry surface.
10. **DO NOT** lift more than one plate at a time (Fig. 10), except with horizontal clamps.
11. **DO NOT** lift tapered beams or members other than ordinary structural steel.
12. **DO** use as many clamps as necessary to balance the load (Fig. 11). Do not try to lift unbalanced loads.
13. **DO** use two or more clamps whenever possible.
14. **DO NOT** exceed the combined WLL of two clamps when using two or more clamps (Fig. 11).
15. **DO NOT** attach a clamp directly to the crane hook. Use a sling between the crane hook and the clamps to minimize interference in clamp operation and its ability to stay in the right place on the plate.
16. **DO NOT** stand near the load when lifting. The operator should stand clear of the load and should never lift over people or machinery (Fig. 14).
17. **DO NOT** misuse a clamp. Never lift a plate from the bottom of a stack (Fig. 12).
18. **DO NOT** rush. Lift slowly and smoothly.

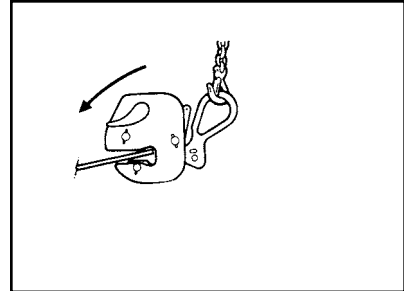

Figure 9

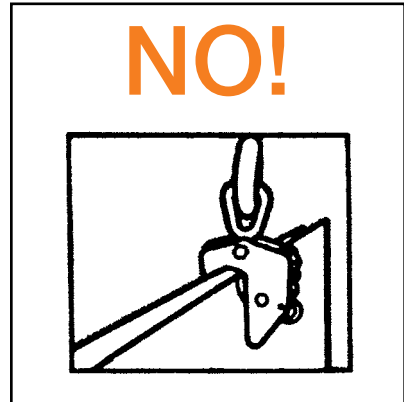

Figure 10

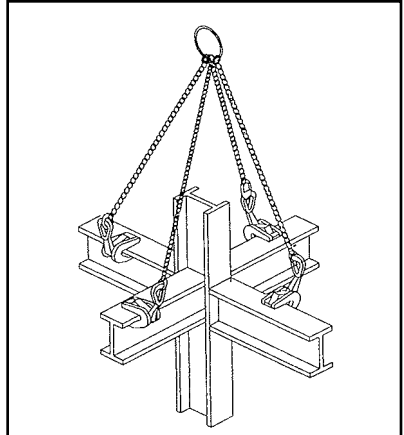

Figure 11

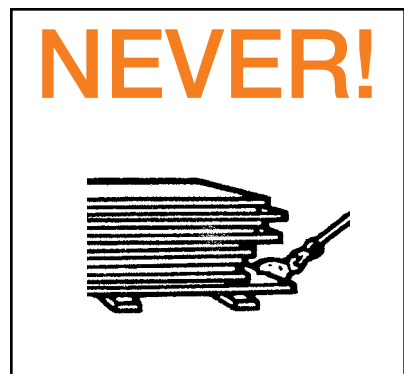

Figure 12

19. **DO NOT** bump the load while lifting or moving.  
Bumping the load may cause clamps to release (Fig. 13).
20. **DO NOT** tamper with the cam engaging mechanism of a clamp while making a lift. Always lift and move a load with the clamp in the lever-closed (“lock-closed”) position.
21. **DO NOT** remove a clamp or disengage the cam until the plate or member is fully supported and at rest.
22. **DO NOT** alter a clamp. Use only the manufacturer’s recommended replacement parts. The clamp manufacturer’s specifications include specific materials and manufacturing procedures. **Never grind, weld or in any way alter the clamp as this could cause severe damage or failure.**

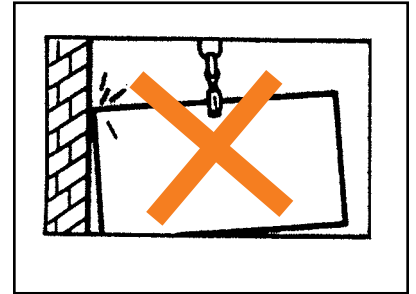

Figure 13

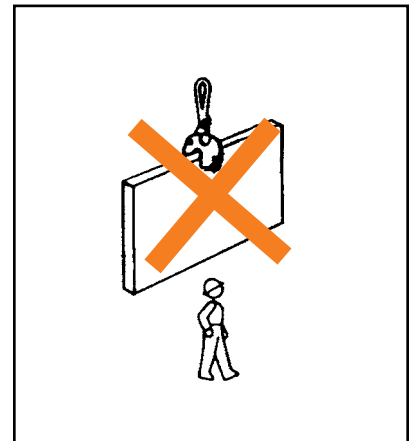

Figure 14

## Model GX

VERTICAL LIFT  
VERTICAL TURN/LIFT  
HORIZONTAL LIFT

SPRING-LOADED CAM

### APPLICATION



Figure 15

The standard GX clamp (Fig. 15) is a versatile clamp used mostly for steel warehousing and benchwork. The GX clamp can be used for vertical, vertical/turn or horizontal lifts. The GX clamp is recommended for turning a single sheet or fabricated structure. Due to its swiveling pad and **spring-loaded cam**, the clamp always stays in contact with the work face of the load, even when the load is turning through 180 degrees. The most exclusive feature of the GX clamp is its **wear indicator system**.

When any of the cam's teeth are flattened, chipped or dulled between the unique wear indicator grooves (Fig. 16), it's time to change the cam. (Always replace the pad at the same time as the cam.) In addition, due to their forged components, **GX clamps have one of the lowest weight-to-Working Load Limit ratio of any clamps sold in the world.** This means they are easy to use and less tiring for the user. The GX design has also been used in several specialized applications, such as:

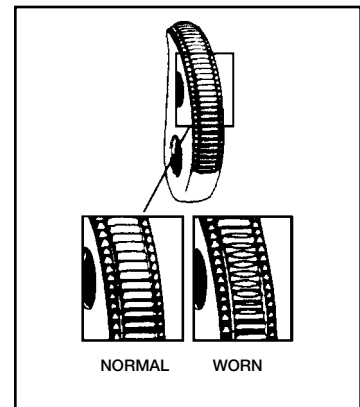

Figure 16

- **GX Structural Clamp** is a variation of the GX body shape and is designed for a secure bite on small or odd-shaped, wide flange beams.
- **GX Chain Connector Clamp** is a standard GX clamp fitted with a chain connector instead of a shackle. Using this clamp increases the flexibility of a multiple leg chain sling.
- **GX Sharp Leg Clamp** is a variation of the standard GX clamp designed to lift stacked plates from horizontal to vertical position. The long sharp leg can be driven between the top two plates to fully engage the clamp. This clamp is not equipped with a swiveling pad and it should not be used for turning a load.

## OPERATION

### Step 1

Before using any Campbell clamp, read the Applications section at the beginning of this manual to be sure the lift is appropriate for the size and style of clamp. Know the type of material to be moved before making a lift. Some exotic steels are too hard to allow the teeth of the cam to sink in. This may be true of structural members and fabricated sections.



**WARNING!:** Do not lift a plate or member with a hardness greater than 400 Brinell (43 Rockwell C)

### Step 2

Choose a clamp with the right capacity and grip range. The model type, capacity and grip range are shown on the face of the clamp (Fig. 17).



Figure 17



**WARNING!:** Never lift a weight greater than the Working Load Limit shown on the clamp.

### Step 3

Inspect the clamp before each lift (Fig. 18).

- A. Inspect the cam and pad for wear and defects. Gripping surfaces must be free off foreign matter. If either the cam or pad are worn or defective, replace both cam and pad at the same time.
- B. Inspect the shackle and visible linkage for elongation, distortion, wear or damage.
- C. Inspect the clamp body for wear, damage or distortion.
- D. Do not use any clamp that needs repair.



Figure 18

If in doubt, refer to the Maintenance and Inspection section of this manual for detailed instructions.

## Step 4

Determine if more than one sling is required to balance the load (Fig. 19). When the size or shape of a plate or fabricated section is too large for one clamp to properly balance the load, the use of a multiple sling or spreader bar is required.

- A. All clamps used in a multiple sling or spreader bar assembly must be rated at the same capacity.
- B. The lifting angle (Fig. 19) between the sling legs on opposite sides of the load should be less or equal to 60 degrees. The lifting angle (Fig. 20) between the sling legs on same side of the load should be less or equal to 20 degrees.
- C. The Working Load Limit of any multiple sling assembly or spreader bar assembly must not be more than the combined Working Load Limit of two clamps, no matter how many clamps are in the assembly.

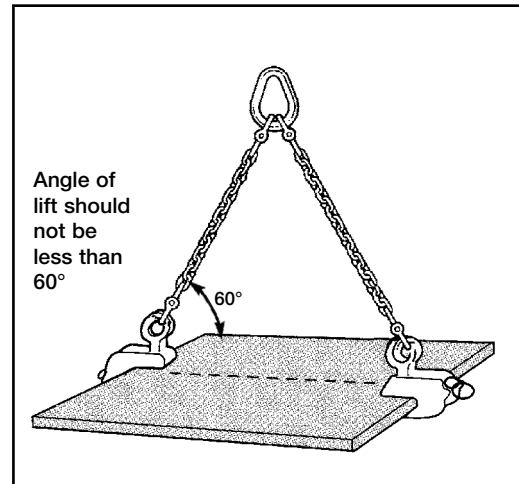

Figure 19

## Step 5

Position the clamp(s) to balance the load. Position the clamp(s) so the lifting force of the crane is directly in line with each clamp's lifting shackle, and the load is evenly distributed (Fig. 20).

**⚠ WARNING!** Never attach a clamp directly to the crane hook. Use a sling between the crane hook and clamp to minimize interference in the clamp operation.

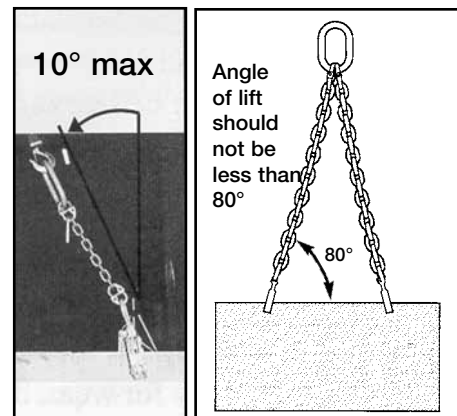

Figure 20

**⚠ WARNING!** Do not side load. Never exceed an angle of 10° from vertical.

## Step 6

Engaging the clamp:

- A. Press down on the lifting shackle until the cam retracts. Occasionally, a cam may jam against a pad. To release, either tap the heel of the shackle, or grasp clamp by the shackle and tap bottom of clamp sharply against floor or other solid surface.
- B. Install the clamp over the plate to the full depth of the throat opening.
- C. Release the shackle so the cam engages the plate.

## Step 7

Lift slowly and smoothly. The operator should stand clear of the load and never lift over people or machinery.



**WARNING!: Do not begin to lift until all personnel are clear of the lift area. Never stand under or near a member being lifted.**



**WARNING!: Do not jerk or bump load while lifting.**

## Step 8

After the plate is in place and at rest, the GX clamp can be removed by retracting the cam away from the plate. To do this, press down on the lifting shackle while at the same time lifting the clamp from the plate. If the cam is difficult to retract, a slight tap on the heel of the shackle or the clamp's body should release it.

## Step 9

Campbell® recommends inspection of each lifting clamp before and after each lift. Refer to the Maintenance and Inspection section of this manual for detailed instructions.



**WARNING!: Do not use a clamp that needs repair.**

## Model GXL

**VERTICAL LIFT  
VERTICAL TURN/LIFT  
HORIZONTAL LIFT  
CAM ENGAGING LEVER  
(LOCKING LEVER)  
SPRING-LOADED CAM**



Figure 21

## APPLICATION

The GXL clamp (Fig. 21) is a versatile clamp most commonly used for steel warehousing and benchwork. The GXL clamp can be used for vertical, vertical/turn or horizontal lifts. The GXL clamp is recommended for the turning of a single sheet or fabricated structure. Due to its swiveling pad and **spring-loaded cam**, the clamp always stays in contact with the work face of the load, even when the load is turning through 180 degrees. In addition, the clamp is also equipped with a cam engaging lever which allows a convenient way of closing and opening the clamp. The most exclusive feature of the GXL clamp is its **wear indicator system**. When any of the cam's teeth are flattened, chipped or dulled between the unique wear indicator grooves, (Fig. 22) it's time to change the cam. (Always replace the pad at the same time as the cam.) In addition, due to their forged components, **GXL clamps have one of the lowest weight-to-Working Load Limit ratios of any clamps sold in the world**. This means they are easy to use and less tiring for the user.

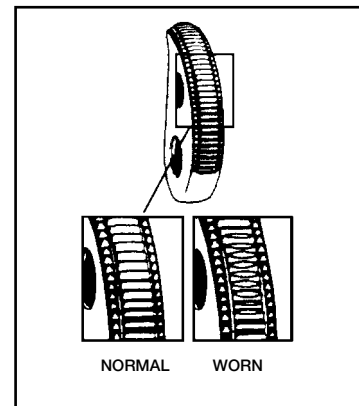

Figure 22

## OPERATION

### Step 1

Before using any Campbell® clamp, refer to the Applications section at the beginning of this manual to be sure the lift to be made is appropriate for the size and style of clamp. Know the type of material to be moved before making a lift. Some exotic steels are too hard to allow the teeth of the cam to sink in. This may be true of structural members and fabricated sections.



**WARNING!: Do not lift a plate or member with a hardness greater than 400 Brinell (43 Rockwell C)**

### Step 2

Select a clamp with the appropriate capacity and grip range.

The model designation, capacity and grip range are indicated on the face of the clamp (Fig. 23).

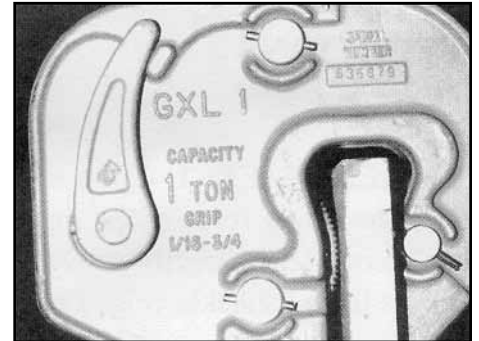

Figure 23



**WARNING!: Never lift a weight greater than the Working Load Limit shown on the clamp.**

### Step 3

Inspect the clamp before each lift (Fig. 24).

- A. Inspect the cam and pad for wear and defects. Gripping surfaces must be free of foreign matter. If either the cam or pad are worn or defective, replace the cam and pad at the same time.
- B. Inspect the shackle and visible linkage for elongation, distortion, wear or damage.
- C. Inspect the clamp body for wear, damage or distortion.
- D. Do not use any clamp that needs repair.



Figure 24

If in doubt, refer to the Maintenance and Inspection section of this manual for detailed instructions.

## Step 4

Determine if more than one sling is required to balance the load (Fig. 25). When the size or shape of a plate or fabricated section is too large for one clamp to properly balance the load, the use of a multiple sling or spreader bar is required.

- A. All clamps used in a multiple sling or spreader bar assembly must be rated at the same capacity.
- B. The lifting angle (Fig. 25) between the sling legs on opposite sides of the load should be less or equal to 60 degrees. The lifting angle (Fig. 26) between the sling legs on same side of the load should be less or equal to 20 degrees.
- C. The Working Load Limit of any multiple sling assembly or spreader bar assembly must not be more than the combined Working Load Limit of two clamps, no matter how many clamps are in the assembly.

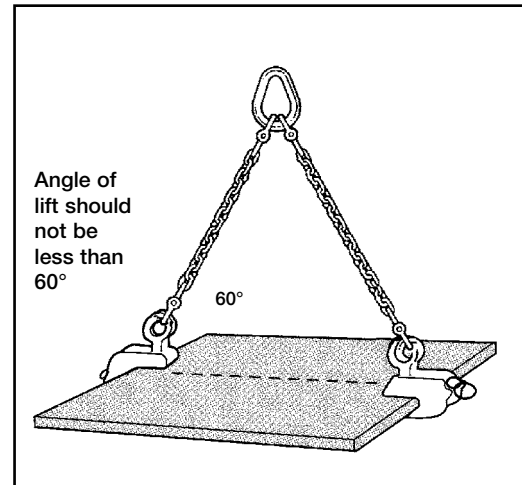

Figure 25

## Step 5

Position the clamp(s) to balance the load. Position the clamp(s) so the lifting force of the crane is directly in line with each clamp's lifting shackle, and the load is evenly distributed (Fig. 26).

**⚠ WARNING!:** Never attach a clamp directly to the crane hook. Use a sling between the crane hook and clamp to minimize interference in the clamp operation.

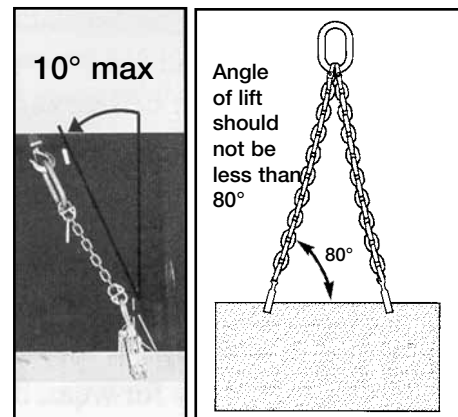

Figure 26

**⚠ WARNING!:** Do not side load. Never exceed an angle of 10° from vertical.

## Step 6

Engaging the clamp:

### VERTICAL LIFT

### VERTICAL TURN/LIFT

- A. Lower the clamp onto the plate with the lever in the “lever open” position until clamp rests on plate (Fig. 27). Occasionally, a cam may jam against a pad. To release, either tap the heel of the shackle, or grasp clamp by the shackle and tap bottom of clamp sharply against floor or other solid surface.
- B. Move lever to “lever closed” position while pushing the clamp down to ensure the plate is inserted to the full depth of the throat (Fig. 28 and 29). The cam is forced against the plate and you are now ready to lift the plate.

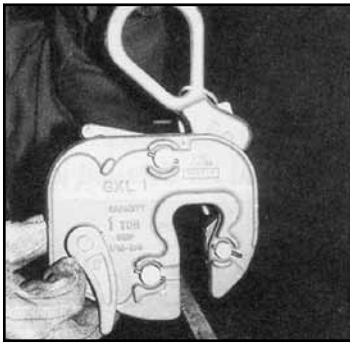

Figure 27

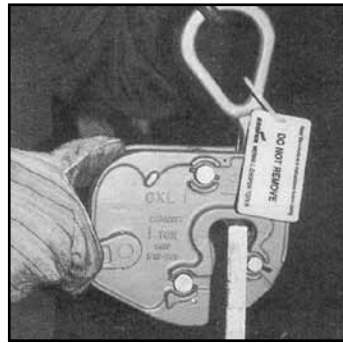

Figure 28

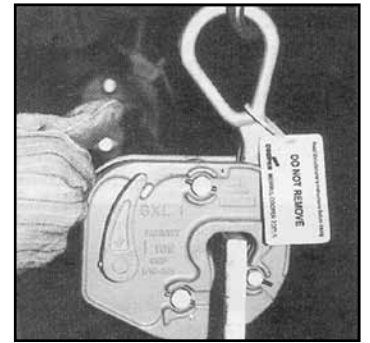

Figure 29

### HORIZONTAL LIFT

- A. Place the clamp on the plate with the lever in “lever open” position and the short leg under the plate (Fig. 27). Occasionally, a cam may jam against a pad. To release, either tap the heel of the shackle, or grasp clamp by the shackle and tap bottom of clamp sharply against floor or other solid surface.
- B. Push the clamp onto the plate until the plate touches the back of the clamp’s throat and move lever to “lever closed” position (Fig. 28).
- C. Ensure that the plate is inserted to the full depth of the plate and the cam is engaged against the plate. You are now ready to lift the plate (Fig. 29).

## Step 7

Lift slowly and smoothly. The operator should stand clear of the load and never lift over people or machinery.



**WARNING!:** Do not begin to lift until all personnel are clear of the lift area. Never stand under or near a member being lifted.



**WARNING!:** Do not jerk or bump load while lifting.

## Step 8

After the plate is fully supported and at rest, the GXL clamp can be removed by retracting the cam away from the plate. To do so, open the lever to the “open” position or, press down on the lifting shackle while at the same time lifting the clamp from the plate. If the cam is difficult to retract, a slight tap on the heel of the shackle or the clamp’s body should release it.



**WARNING!: Never tap the cam engaging lever or use a cheater pipe to force lever open.**

## Step 9

Campbell® recommends inspection of each lifting clamp before and after each lift. Refer to the Maintenance and Inspection section of this manual for detailed instructions.



**WARNING!: Do not use a clamp that needs repair.**

## Model SAC

VERTICAL LIFT  
VERTICAL TURN/LIFT  
HORIZONTAL LIFT

SCREW-ADJUSTED CAM



Figure 30

## APPLICATION

The SAC clamp (Fig. 30) is capable of handling steel plate or fabricated structures from horizontal through a 180 degree arc. The SAC clamp has a convex, serrated cam that swivels on a ball joint. This clamp has a minimum number of moving parts.

## OPERATION

### Step 1

Before using any Campbell® clamp, refer to the Applications section at the beginning of this manual to be sure the lift to be made is appropriate for the size and style of clamp. Know the type of material to be moved before making a lift. Some exotic steels are too hard to allow the teeth of the cam to sink in. This may be true of structural members and fabricated sections.



**WARNING!: Do not lift a plate or member with a hardness greater than 400 Brinell (43 Rockwell C)**

### Step 2

Select a clamp with the appropriate capacity and grip range. The model designation, capacity and grip range are indicated on the face of the clamp.



**WARNING!: Never lift a weight greater than the Working Load Limit shown on the clamp.**

### Step 3

Inspect the clamp before each lift (Fig. 31).

- A. Inspect the cam and pad for wear and defects. Gripping surfaces must be free of foreign matter. If either the cam or pad are worn or defective, replace the cam and pad at the same time.
- B. Inspect the shackle and visible linkage for elongation, distortion, wear or damage.
- C. Inspect the clamp body for wear, damage or distortion.
- D. Do not use any clamp that needs repair.

If in doubt, refer to the Maintenance and Inspection section of this manual for detailed instructions.

### Step 4

Determine if more than one sling is required to balance the load. When the size or shape of a plate or fabricated section is too large for one clamp to properly balance the load, the use of a multiple sling or spreader bar is required (Fig. 32).

- A. All clamps used in a multiple sling or spreader bar assembly must be rated at the same capacity.
- B. The lifting angle (Fig. 32) between the sling legs on opposite sides of the load should be less or equal to 60 degrees. The lifting angle (Fig. 33) between the sling legs on same side of the load should be less or equal to 40 degrees.
- C. The Working Load Limit of any multiple sling assembly or spreader bar assembly must not be more than the combined Working Load Limit of two clamps, no matter how many clamps are in the assembly.



Figure 31

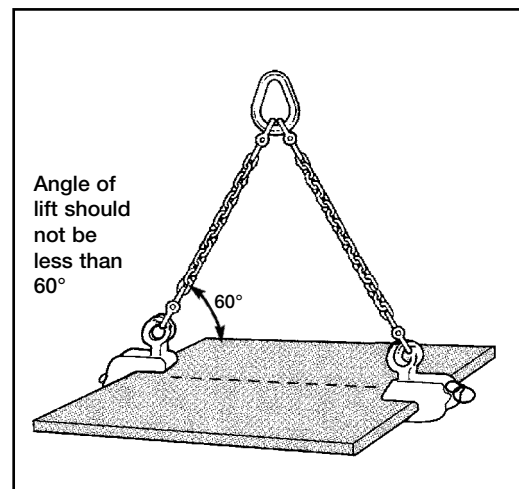

Figure 32

## Step 5

Position the clamp(s) to balance the load. Position the clamp(s) so the lifting force of the crane is directly in line with each clamp's lifting shackle, and the load is evenly distributed (Fig. 33).

**⚠ WARNING!: Never attach a clamp directly to the crane hook. Use a sling between the crane hook and clamp to minimize interference in the clamp operation.**

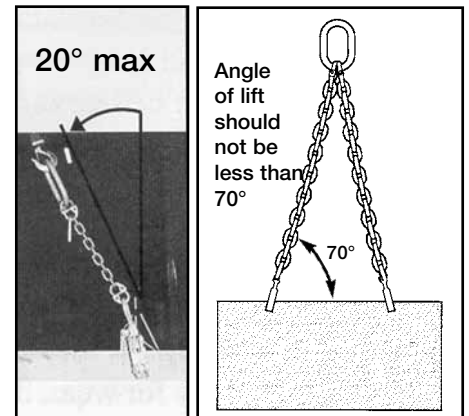

Figure 33

**⚠ WARNING!: Do not side load. Never exceed an angle of 20° from vertical.**

## Step 6

Engaging the clamp:

VERTICAL LIFT

VERTICAL TURN/LIFT

- Attach the clamp to the plate so that it is square with the cam. Ensure the plate is inserted to the full depth of the throat.
- Turn the cam screw until the cam just touches the work and the center rings are in contact with plate.
- Tighten the screw with the torque limiting handle provided (SAC-1, SAC-3 & SAC-6).

**⚠ WARNING!: Do not over-tighten screw! Screw needs to be hand tight only.**

HORIZONTAL LIFT

- Place the pad leg under the plate.
- Lift the clamp slightly so that the pad on the swiveling jaw contacts the plate.
- Turn the cam screw until the cam just touches the work and the center rings are in contact with the plate.

**⚠ WARNING!: Do not over-tighten screw! Screw needs to be hand tight only.**

## Step 7

Lift slowly and smoothly. The operator should stand clear of the load and never lift over people or machinery.



**WARNING!: Do not begin to lift until all personnel are clear of the lift area. Never stand under or near a member being lifted.**



**WARNING!: Do not jerk or bump load while lifting.**

## Step 8

After the plate is fully supported and at rest, the SAC clamp can be removed by loosening the screw.

## Step 9

Campbell® recommends inspection of each lifting clamp before and after each lift. Refer to the Maintenance and Inspection section of this manual for detailed instructions.



**WARNING!: Do not use a clamp that needs repair.**

## Model E

**VERTICAL LIFT  
VERTICAL TURN /LIFT  
HORIZONTAL LIFT**

**CAM ENGAGING LEVER  
(LOCKING LEVER)**



Figure 34

## APPLICATION

The E clamp (Fig. 34) incorporates a “Lever-Open/Lever-Closed” feature which facilitates attaching and removing the clamp. The E clamp is for vertical, vertical/turn and horizontal lifting. Its large throat opening gives a wider grip range. The swivel pad rotates for a quicker release. The E clamp also features a large shackle opening.

## OPERATION

### Step 1

Before using any Campbell® clamp, refer to the Application section at the beginning of this manual to be sure the lift to be made is appropriate for the size and style of clamp. Know the type of material to be moved before making a lift. Some exotic steels are too hard to allow the teeth of the cam to sink in. This may be true of structural members and fabricated sections.



**WARNING!:** Do not lift a plate or member with a hardness greater than 400 Brinell (43 Rockwell C)

### Step 2

Select a clamp with the appropriate capacity and grip range.  
The model designation, capacity and grip range are shown on the face of the clamp (Fig. 35).



Figure 35



**WARNING!:** Never lift a weight greater than the Working Load Limit shown on the clamp.

### Step 3

Inspect the clamp before each lift (Fig. 36).

- A. Inspect the cam and pad for wear and defects. Gripping surfaces must be free of foreign matter. If either the cam or pad are worn or defective, replace the cam and pad at the same time.
- B. Inspect the shackle and visible linkage for elongation, distortion, wear or damage.
- C. Inspect the clamp body for wear, damage or distortion.
- D. Do not use any clamp that needs repair.



Figure 36

If in doubt, refer to the Maintenance and Inspection section of this manual for detailed instructions.

### Step 4

Determine if more than one sling is required to balance the load. When the size or shape of a plate or fabricated section is too large for a pair of clamps to properly balance the load, the use of a multiple sling or spreader bar is required (Fig. 37).

- A. All clamps utilized in a multiple sling or spreader bar assembly must be rated at the same capacity.
- B. The lifting angle (Fig. 37) between the sling legs on opposite sides of the load should be less or equal to 60 degrees. The lifting angle (Fig. 38) between the sling legs on same side of the load should be less or equal to 20 degrees.

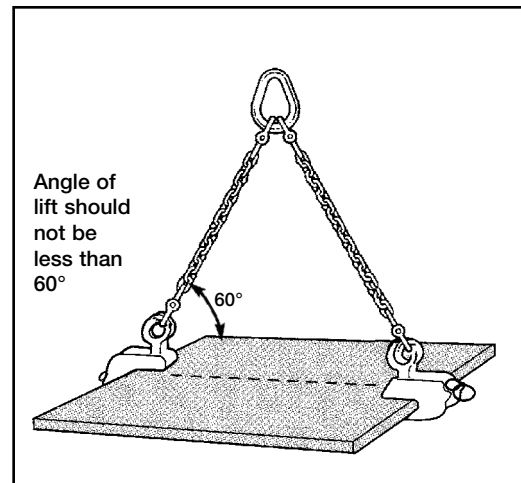

Figure 37

C. The Working Load Limit of any multiple slings assembly or spreader bar assembly must not be more than the combined Working Load Limit of two clamps, regardless of the number of clamps in the assembly.

### Step 5

Position the clamp(s) to balance the load. Position the clamp(s) so the lifting force of the crane is directly in line with each clamp's lifting shackle, and the load is evenly distributed (Fig. 38).

**⚠ WARNING!: Never attach a clamp directly to the crane hook. Use a sling between the crane hook and clamp to minimize interference in the clamp operation.**

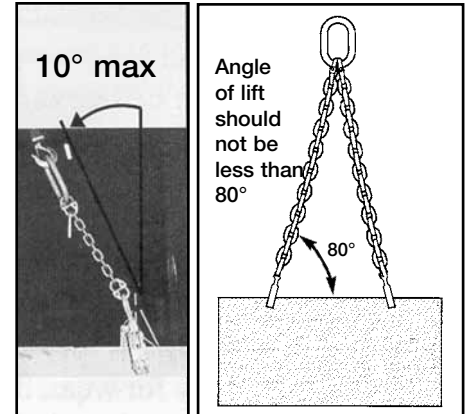

Figure 38

**⚠ WARNING!: Do not side load. Never exceed an angle of 10° from vertical.**

### Step 6

Engaging the clamp:

#### HORIZONTAL

- Pull tension arm down away from shackle and place clamp on plate with short leg underneath.
- Raise tension arm to engage cam against plate.
- Lift clamp body until pad touches plate, at the same time push clamp body so back of throat touches end of plate.

#### VERTICAL

- Pull tension arm down to retract cam and lower clamp onto plate to the full depth of the throat.
- Raise tension arm to upper position to engage cam against plate.

### Step 7

Lift slowly and smoothly. The operator should stand clear of the load and never lift over people or machinery.

**⚠ WARNING!: Do not begin to lift until all personnel are clear of the lift area. Never stand under or near a member being lifted.**

 **WARNING!: Do not jerk or bump load while lifting.**

### Step 8

After the plate is fully supported and at rest, the E clamps can be removed by lowering the tension arm. The cam should release. If cam sticks, tap clamp body.

 **WARNING!: Never tap the tension arm or use a cheater pipe to force arm open.**

### Step 9

Campbell® recommends inspection of each lifting clamp before and after each lift. Refer to the Maintenance and Inspection section of this manual for detailed instructions.

 **WARNING!: Do not use a clamp that needs repair.**

## Model H

### HORIZONTAL

### SPRING-LOADED CAM

### APPLICATION

The Model H is a horizontal lifting clamp intended to be used in pairs (Fig. 39) or sets of pairs for transporting plate. A single operator can use these clamps due to their dual spring, which hold the cam of the first clamp in place while the second is being positioned.



Figure 39

### OPERATION

#### Step 1

Before using any Campbell® clamp, refer to the Application section at the beginning of this manual to be sure the lift to be made is appropriate for the size and style of clamp. Know the type of material to be moved before making a lift. Do not lift plate, or plates, if they will buckle under load. Some exotic steels are too hard to allow the teeth of the cam to sink in. This may be true of structural members and fabricated sections.



**WARNING!: Do not lift a plate or member with a hardness greater than 400 Brinell (43 Rockwell C)**

#### Step 2

Select a clamp with the appropriate capacity and grip range. The model designation, capacity and grip range are shown on the face of the clamp (Fig;. 40).



**WARNING!: Never lift a weight greater than the Working Load Limit shown on the clamp.**



Figure 40

Note: The 3T WLL for the “H” clamp is 3T per clamp.

### Step 3

Inspect the clamp before each lift (Fig. 41).

- A. Inspect the cam and pad for wear and defects. Gripping surfaces must be free of foreign matter.
- B. Inspect the shackle and visible linkage for elongation, distortion, wear or damage.
- C. Inspect the clamp body for wear, damage or distortion.
- D. Do not use any clamp that needs repair.



Figure 41

If in doubt, refer to the Maintenance and Inspection section of this manual for detailed instructions.

### Step 4

Determine if more than one sling is required to balance the load. When the size or shape of a plate or fabricated section is too large for a pair of clamps to properly balance the load, the use of a multiple sling or spreader bar is required (Fig. 49).

- A. All clamps utilized in a multiple sling or spreader bar assembly must be rated at the same capacity.
- B. The lifting angle (Fig. 42) between the sling legs on opposite sides of the load should be less or equal to 60 degrees ( $\beta \leq 60^\circ$ ). The lifting angle between the sling legs on same side of the load should be less or equal to 20 degrees ( $\theta \leq 20^\circ$ ).
- C. The Working Load Limit of any multiple sling assembly (Fig. 42) or spreader bar assembly (Fig. 43) must not be more than the combined Working Load Limit of two clamps, regardless of the number of clamps in the assembly.

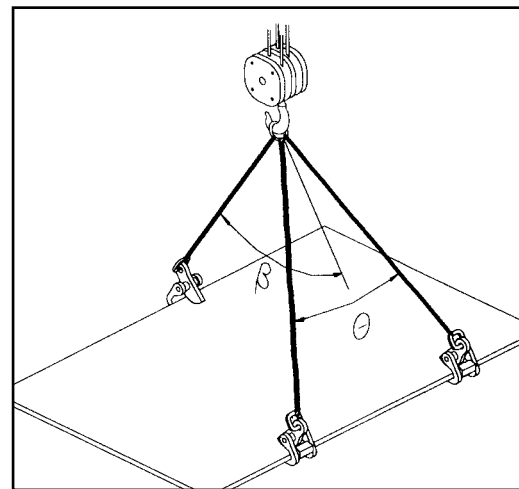

Figure 42

## Step 5

Position the clamp(s) to balance the load.  
Position the clamp(s) so the lifting force of the crane is directly in line with each clamp's lifting shackle, and the load is evenly distributed (Fig. 43).

**⚠ WARNING!:** Never attach a clamp directly to the crane hook. Use a sling between the crane hook and clamp to minimize interference in the clamp operation.

**⚠ WARNING!:** Do not side load. Never exceed an angle of 10° from vertical.

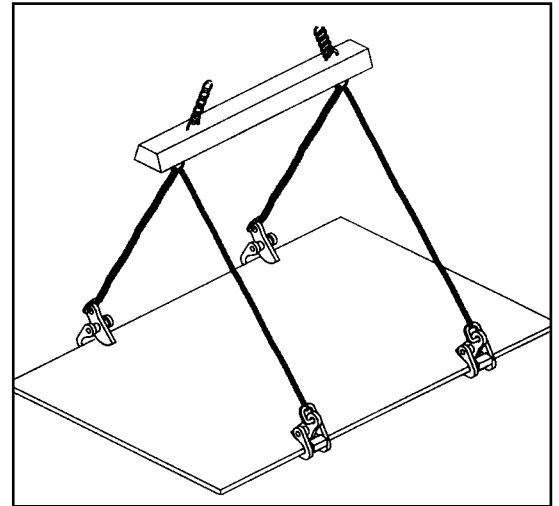

Figure 43

## Step 6

Engaging the clamp:

HORIZONTAL

- A. Press down on the back side of the cam until the cam retracts.
- B. Install the clamp over the plate to the full depth of the throat opening.
- C. Release the back side of the cam so the cam engages the plate.

## Step 7

Lift slowly and smoothly. The operator should stand clear of the load and never lift over people or machinery.

**⚠ WARNING!:** Do not begin to lift until all personnel are clear of the lift area. Never stand under or near a member being lifted.

**⚠ WARNING!:** Do not jerk or bump load while lifting.

## Step 8

After the plate is fully supported and at rest, the H clamp can be removed by retracting the cam. To do so, press down on the cam while at the same time slide the clamp away from the plate.

## Step 9

Campbell® recommends inspection of each lifting clamp before and after each lift. Refer to the Maintenance and Inspection section of this manual for detailed instructions.



**WARNING!:** Do not use a clamp that needs repair.

## Model GX RPC

VERTICAL LIFT  
VERTICAL TURN/LIFT  
HORIZONTAL LIFT

SPRING-LOADED CAM



Figure 44

## APPLICATION

GX RPC clamp (Fig. 44) has a rubber-covered pad and a cam of relatively smooth metal conditioned to grip tightly. It lifts plates with minimum marring and should be used with plates whose finish appearance is important and for plates with hardness over 400 Brinell (43 Rockwell C). The teeth of standard cams cannot properly grip plates over this hardness level. It is recommended to use these clamps in pairs and with a spreader bar.

## OPERATION

### Step 1

Before using any Campbell® clamp, refer to the Applications section at the beginning of this manual to be sure the lift to be made is appropriate for the size and style of clamp. Know the type of material to be moved before making a lift.

**⚠ WARNING!: Do not attach this clamp to oily, coated or freshly painted surfaces.**

### Step 2

Select a clamp with the appropriate capacity and grip range. The model designation, capacity and grip range are shown on the face of the clamp (Fig. 45).

**⚠ WARNING!: Never lift a weight greater than the Working Load Limit shown on the clamp.**



Figure 45

### Step 3

Inspect the clamp before each lift (Fig. 46).

- A. Inspect the cam and pad for wear and defects. Gripping surfaces must be free of foreign matter. If either the cam or pad are worn or defective, replace the cam and pad at the same time.
- B. Inspect the shackle and visible linkage for elongation, distortion, wear or damage.
- C. Inspect the clamp body for wear, damage or distortion.
- D. Do not use any clamp that needs repair.



Figure 46

If in doubt, refer to the Maintenance and Inspection section of this manual for detailed instructions.

### Step 4

Determine if more than one sling is required to balance the load (Fig. 47). When the size or shape of a plate or fabricated section is too large for a pair of clamps to properly balance the load, the use of a multiple sling or spreader bar is required.

- A. All clamps utilized in a multiple sling or spreader bar assembly must be rated at the same capacity.
- B. The lifting angle (Fig. 47) between the sling legs on opposite sides of the load should be less or equal to 60 degrees. The lifting angle (Fig. 48) between the sling legs on same side of the load should be less or equal to 20 degrees.

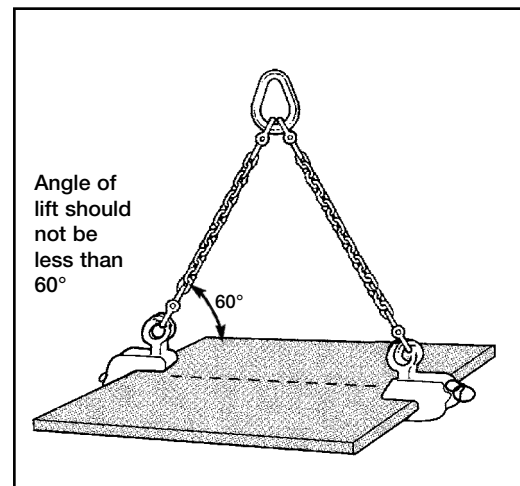

Figure 47

- C. The Working Load Limit of any multiple sling assembly or spreader bar assembly must not be more than the combined Working Load Limit of two clamps, regardless of the number of clamps in the assembly.

## Step 5

Position the clamp(s) to balance the load. Position the clamp(s) so the lifting force of the crane is directly in line with each clamp's lifting shackle, and the load is evenly distributed (Fig. 48).

**⚠ WARNING!: Never attach a clamp directly to the crane hook. Use a sling between the crane hook and clamp to minimize interference in the clamp operation.**

**⚠ WARNING!: Do not side load. Never exceed an angle of 10° from vertical.**

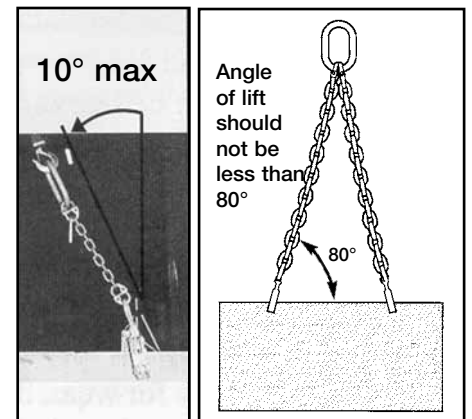

Figure 48

## Step 6

Engaging the clamp:

- A. Press down on the lifting shackle until the cam retracts.
- B. Install the clamp over the plate to the full depth of the throat opening.
- C. Release the shackle so the cam engages the plate.

## Step 7

Lift slowly and smoothly. The operator should stand clear of the load and never lift over people or machinery.

**⚠ WARNING!: Do not begin to lift until all personnel are clear of the lift area. Never stand under or near a member being lifted.**

**⚠ WARNING!: Do not jerk or bump load while lifting.**

## Step 8

After the plate is fully supported and at rest, the GXRPC clamp can be removed by retracting the cam away from the plate. To do so, press down on the lifting shackle

while at the same time slide the clamp away from the plate. If the cam is difficult to retract, a slight tap on the base of the shackle or the clamp's body should release it.

## Step 9

Campbell® recommends inspection of each lifting clamp before and after each lift. Refer to the Maintenance and Inspection section of this manual for detailed instructions.



**WARNING!:** Do not use a clamp that needs repair.

## Duplex Hand Grip

This clamp is designed to carry or pull any metal, plastic or structural shapes that will fit into its jaws. It grips and releases automatically and is small and lightweight. The Duplex Hand Grip is also furnished with an eye nut rather than a handle for conveyor applications (Fig. 49).



Figure 49

**⚠ WARNING!: Do not exceed Working Load Limit of 500 lb (225 kg).**

**⚠ WARNING!: Inspect clamp. If cam teeth are worn, or if clamp is damaged, do not use clamp (Fig. 50).**

**⚠ WARNING!: Do not lift more than one plate (Fig. 51).**

**⚠ WARNING!: Attach clamp so that it is square with plate and plate is inserted to full depth of opening.**

**⚠ WARNING!: Position clamp to balance load. A trial tensioning of load will usually indicate proper balance (Fig. 52).**

**⚠ WARNING!: Take up slack slowly. Do not bounce or jerk load (Fig. 53).**

**⚠ WARNING!: All personnel must stand clear of loads while they are being lifted or moved, except for operators of manually lifted hand grips (Fig. 51).**

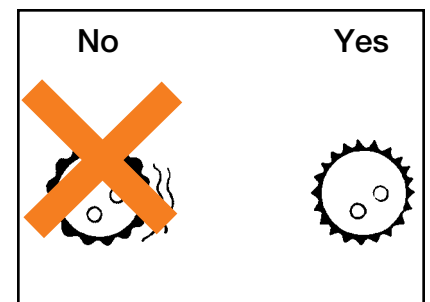

Figure 50

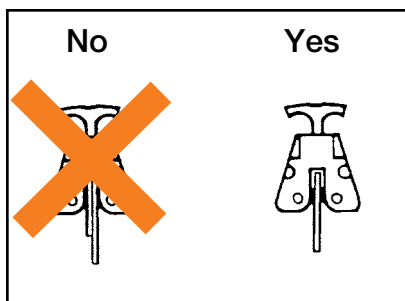

Figure 51

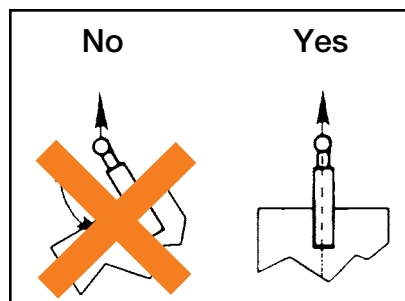

Figure 52

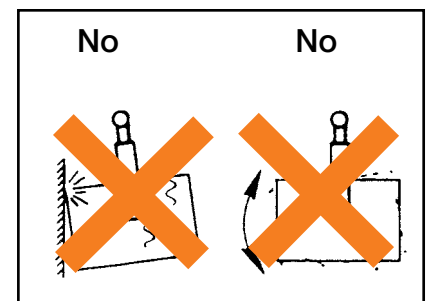

Figure 53

## Drum Handling Equipment

### Single drum lifter, No. 52

The Campbell® drum lifter (Fig. 54) is a completely drop-forged unit for lifting steel drums. It is designed to accommodate a great variety of drums with or without heads removed. It snaps onto the drum and is held there by its spring-loaded cam, even if there is no load. Drums can be lifted from horizontal or vertical position and reversed.



Figure 54

**WARNING!** The clamp must be positioned with the spring-loaded cam on the outside of the drum (Fig. 55).

**WARNING!** This clamp is suitable for lifting steel drums only. This tool is not designed for lifting plastic drums or metal plates or sheets. (Fig. 56).

The cam and pad are the vital working parts of every clamp. They also are the parts subject to wear and should be carefully inspected to assure safe operation (Fig. 57).

**WARNING!** Inspect clamp before each lift. If cam or pad teeth are worn, or spring is weak, or if clamp is damaged, do not use it.

The amount of wear occurs in direct relation to use. Since this cam is for lifting drums only, wear will occur in one area of the cam working surface. Examine the cam surface and compare the worn

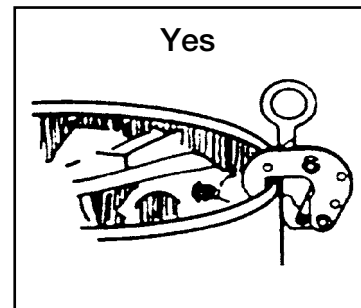

Figure 55

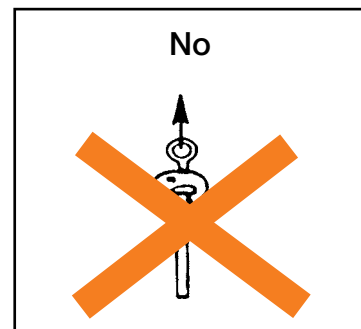

Figure 56

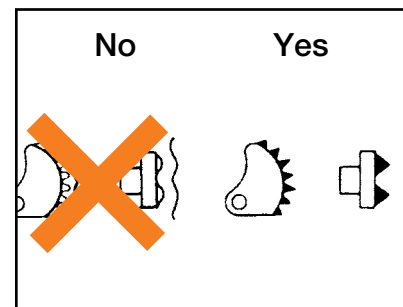

Figure 57

area with any of the unused surface. If the teeth appear to be flattened or dulled, the cam and pad should be replaced. Because shops vary so widely in their operation and frequency of tool use, it is extremely important for you to set up a regular inspection procedure for your particular shop. Refer to the Maintenance and Inspection section at the end of this manual for details.

**⚠ WARNING!: Always know the amount of load before you lift. Do not exceed Working Load Limit (WLL) shown on each clamp.**

Working Load Limit (WLL) of each clamp is 1/2 ton (Fig. 58). If you need to lift a drum that weighs more than 1/2 ton, but less than 1 ton, use Campbell® Twin Drum Lifter (No. 252), Fork Truck Drum Lifter (No. 260) or Chain Sling For Drums (No. 13).

**⚠ WARNING!: Do not lift more than one drum per clamp (Fig. 59).**

**⚠ WARNING!: Take up slack slowly. Do not bounce or jerk load (Fig. 60).**

**⚠ WARNING!: All personnel must stand clear of drum while it is being lifted or removed (Fig. 61).**

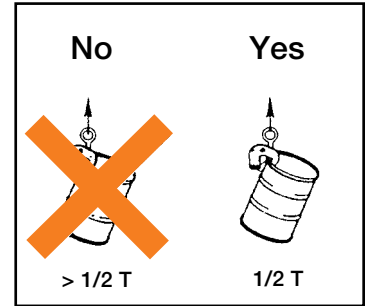

Figure 58

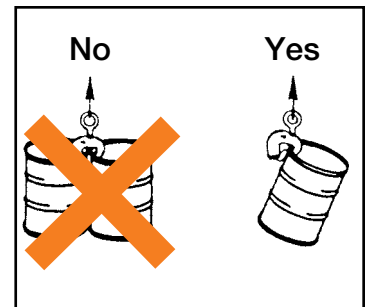

Figure 59

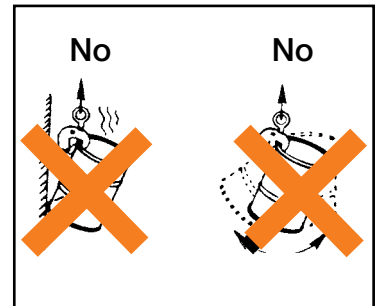

Figure 60

After the drum is at full rest and there is no load on the clamp, the clamp is removed by simply pressing down on the lifting eye and pushing sideways.

**⚠ WARNING!: Do not exceed 60° maximum angle between chain legs (Fig. 62).**

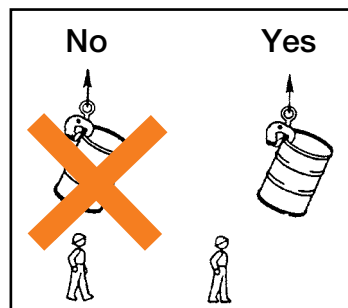

Figure 61

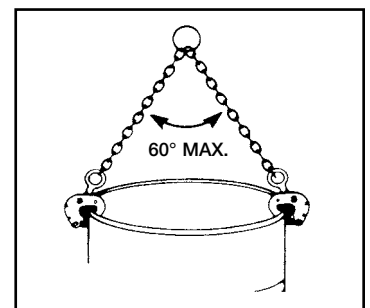

Figure 62

## Twin Drum Lifter, No. 252



Figure 63

This valuable tool (Fig. 63) handles both regular and resealable steel drums without damaging the bead. A recess on the short leg of the clamps accommodates the bead of resealable drums. The clamps are simply turned so that the short legs are on the outside of the drum for this application. For instructions on the use of each of the Twin Drum Lifter clamps, see Single Drum Lifter, No. 52.

**⚠ WARNING!:** Inspect clamp before each lift. If cam or pad teeth are worn, or spring is weak, or if clamp is damaged, do not use it.

**⚠ WARNING!:** Always know the amount of load before you lift. Do not exceed Working Load Limit (WLL) of 1 ton. Drum diameter must be between 17.5 and 25 inches (445 and 635 mm).

**⚠ WARNING!:** All personnel must stand clear of load while it is being lifted or moved.

## Fork Truck Drum Lifter, No. 260

This unique device transforms any forklift truck into an efficient drum handler (Fig. 64). It slips easily onto the forks and grips tightly with knife edged levers. When the load is removed, it can be lifted off easily. The Fork Truck Drum Lifter handles drums with or without heads (Fig. 65). When using clamps to lift one drum, its Working Load Limit is 1 ton.



Figure 64

With shackle reversed in body (Fig. 66), a chain sling can be attached to lift many objects besides drums. Working Load Limit of the Fork Truck Drum Lifter when using center shackle to sling objects is 3 tons.

The Fork Truck Drum Lifter can also be suspended from a crane by the shackle and used to lift single drums. Working Load Limit of the Fork Truck Drum Lifter when using clamps to lift one drum is 1 ton.

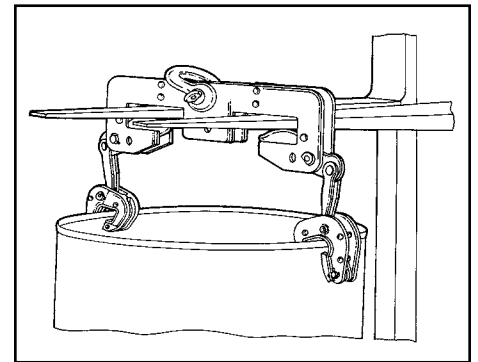

Figure 65

**⚠ WARNING!: Always know the amount of load before you lift. Do not exceed Working Load Limit (WLL).**

Minimum space between the forks is 5.5" (140 mm)  
Maximum width outside the forks is 18" (457 mm)  
Maximum fork thickness is 1.8" (45 mm)  
Maximum fork width is 6.3" (159 mm)  
Drum diameter must be between 17.5 and 25 inches  
(445 and 635 mm)

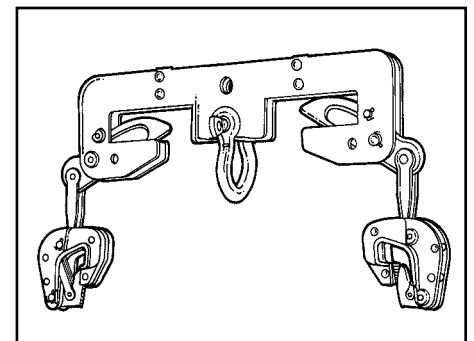

Figure 66

**⚠ WARNING!: Inspect clamp before each lift. If cam or pad teeth are worn, or spring is weak, or if clamp is damaged, do not use it.**

**⚠ WARNING!: All personnel must stand clear of load while it is being lifted or moved.**

## MAINTENANCE & INSPECTION

Campbell® clamps are built to stand up to rough treatment. However, it is not possible to design a clamp to withstand unanticipated outside forces which would interfere with the clamp maintaining its grip on the plate or member. Therefore, it is very important to always perform a visual inspection of each clamp before and after each lift.

A thorough inspection should be performed periodically, depending on individual shop conditions, utilizing the following procedures. Keep written records of the date of inspection, the condition of the clamp and repairs made (Fig. 67). Inspection records should be reviewed regularly.

Clamp No.: _____ Department: _____									
Frequency of Inspection: _____									
Make notes on reverse side as to any special findings or repairs made.									
Date	Cam OK or Replaced	Pad OK or Replaced	Linkage OK	Shackle OK	Body OK	Chain OK or Replaced	Reconditioned Clamp	Replace Clamp	Inspector

Figure 67

## VISUAL INSPECTION

Perform visual inspection of each clamp before and after each lift. This inspection does not require the disassembly of the clamp. Though this inspection may take a minute or two, it is very important in order to ensure a safe work environment (Fig. 68).

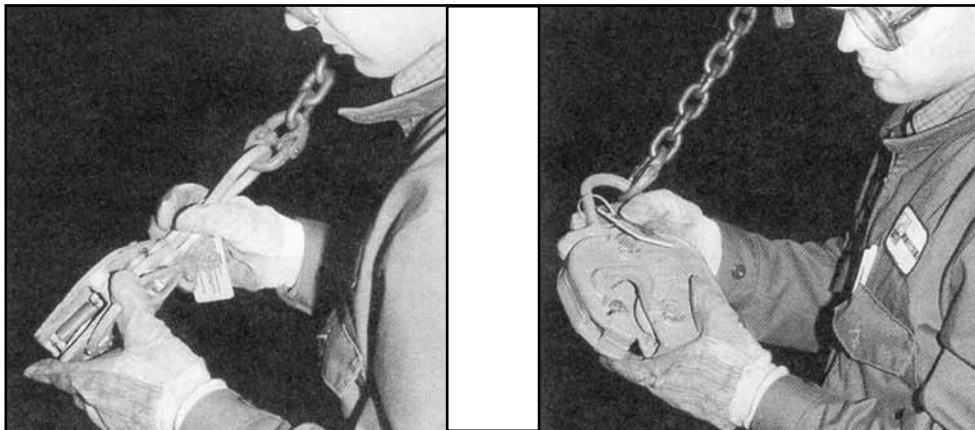

Figure 68

## INSPECTION

### *Inspection of Cams*

Inspect the cam for chipped or worn teeth (Fig. 69). Teeth must be free of foreign matter. Inspect the cam for fractures. The cam on a SAC clamp should swivel freely about the screw. If it does not swivel properly, remove the cam from the screw and inspect inside the cam and screw ball head.

**⚠ WARNING!: Cams with fractures, worn or chipped teeth must be replaced. If any tooth is worn, chipped or dulled more than 50% along the length of its crown, replace the cam. Replace the pad at the same time.**

### *Inspection of Pads*

Campbell clamps utilize a fixed pad or swivel pad. Inspect the pad for worn or chipped serration (Fig. 70). Serration must be free of foreign matter.

**⚠ WARNING!: Pads with worn or fractured serrations must be replaced. If any tooth is worn, chipped or dulled more than 50% along the length of its crown, replace the pad. Replace the cam at the same time.**

### *Inspection of Shackle*

- A. Inspect the shackle for bending at the rivet section, which is an indication of side pull (Fig. 71).
- B. Inspect the shackle eye for elongation.
- C. Inspect the shackle for fractures.

**⚠ WARNING!: Shackles which are bent, or which exhibit elongation or fractures, must be replaced.**

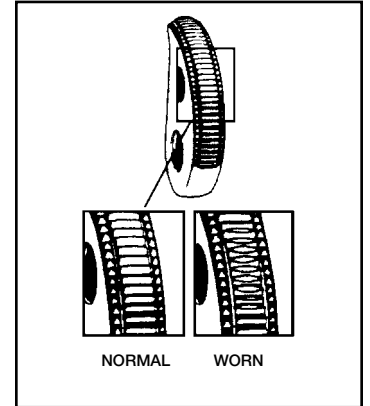

Figure 69

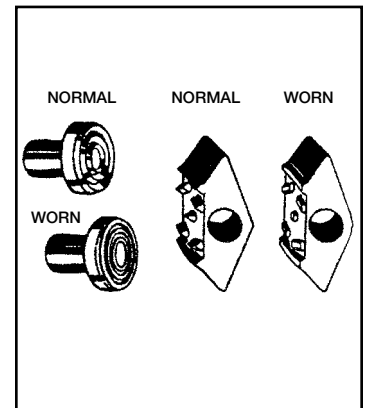

Figure 70

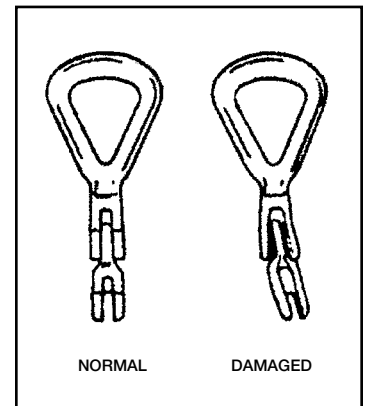

Figure 71

## Inspection of Clamp's Body

- A. Inspect the throat width of the clamp (Fig. 72).  
The width at the base should be the same as at the top.
- B. Inspect the weld and external surfaces for fractures, wear or distortion.
- C. Inspect the body rivets for worn heads.

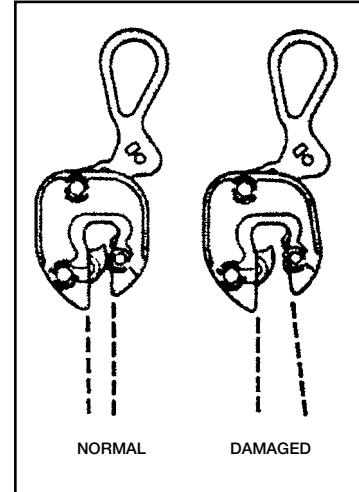

Figure 72

**⚠ WARNING!: Clamps with distorted throat openings, worn body rivets, fractured welds/external surfaces, must be replaced and must not be repaired.**

## Inspection of Springs

- A. Inspect spring for distortion.
- B. Inspect spring for fractures.
- C. Inspect spring for sufficient tension. To do so, when the clamp is fully assembled and in the locked position, the spring should be strong enough to hold the cam against the pad.

**⚠ WARNING!: Clamps with elongated or fractured springs must be replaced.**

## Inspection of Cam Screws (on SAC clamps)

- A. Inspect the screw for distortion, worn or damaged threads.
- B. The ball head where the cam mounts should be free of foreign matter, allowing the free rotation of the cam.

**⚠ WARNING!: Screws with damaged or worn threads, or with distortion, must be replaced.**

**⚠ WARNING!: Do not over-tighten! Screw needs to be hand tight only.**

### *Inspection of Linkage Rivets*

- A. Inspect rivets for loose connections.
- B. Inspect rivets for wear or fractures (Fig. 73).
- C. Inspect rivets for bending.

**⚠ WARNING!: Rivets with fractures or distortion must be replaced. Do not reuse rivets once the linkage has been disassembled.**

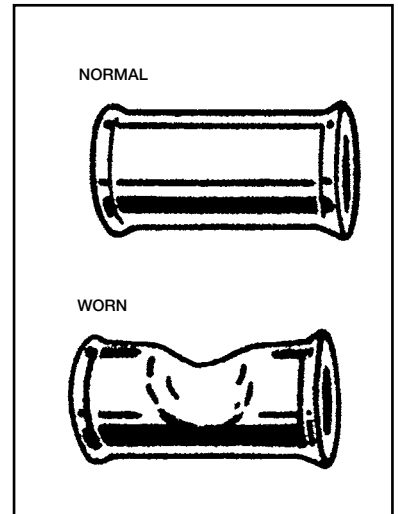

Figure 73

### *Inspection of Pins*

- A. Inspect the pins for distortion.
- B. Inspect pins for fractures or wear.

**⚠ WARNING!: Pins with fractures, distortion, or wear must be replaced.**

### *Inspection of Chains*

Chains supplied with clamps should also be inspected carefully (Fig. 74). To do this, use a Campbell wear gauge. Inspect chains link by link, checking for distorted, stretched or cracked links, nicks or gouges, pitted links and excessive wear of bearing surfaces and barrels.

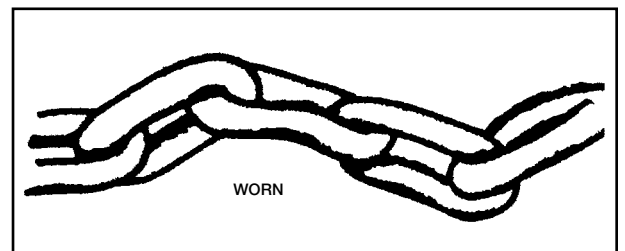

Figure 74

